

UHP-1500 Series

1500W Conduction Cooling with PFC Switching Supply



Features

- Slim and Low profile (41mm)
- Fanless and conduction-cooled design
- Built-in active PFC function
- -30~+70°C working temperature
- Output voltage and constant current level programmable
- Protections: Short circuit / Overload / Over voltage / Over temperature
- Built-in remote ON-OFF control
- DC OK active signal
- Operating altitude up to 5000 meter (Note.8)
- LED indicator for power on
- Optional PMBus or CANBus protocol
- 5 years warranty

Applications

- Industrial automation machinery
- Industrial control system
- Mechanical and electrical equipment
- Electronic instruments, equipment or apparatus
- Test and measurement instrument
- Laser related machine
- Charging related equipment
- Household appliances
- Power Sourcing Equipment of PoE (48V model: DC O/P range 48~57.6V)

GTIN CODE

MW Search: <https://www.meanwell.com/serviceGTIN.aspx>

Description

UHP-1500 series is a 1500W single-output slim type power supply with 41mm of low profile design. Adopting the full range 90~264VAC input, the entire series provides an output voltage line of 24V and 48V. In addition to the high efficiency up to 96%, that the whole series operates from -30°C ~ 70°C under air convection without fan. UHP-1500 has the complete protection functions and 5G anti-vibration capability; It is complied with the international safety regulations such as TUV BS EN/EN62368-1, UL62368-1. UHP-1500 series serves as a high performance power supply solution for various industrial applications.

Model Encoding

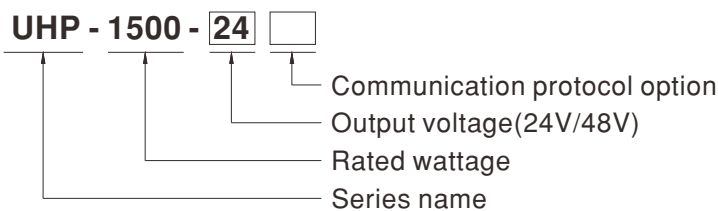

Type	Communication Protocol	Note
Blank	None	In Stock
PM	PMBus protocol	By request
CAN	CANBus protocol	By request

UHP-1500 Series

1500W Conduction Cooling with PFC Switching Supply



SPECIFICATION

MODEL		UHP-1500-24	UHP-1500-48	
OUTPUT	DC VOLTAGE	24V	48V	
	RATED CURRENT	62.5A	31.5A	
	RATED POWER	1500W	1512W	
	RIPPLE & NOISE (max.) Note.2	240mVp-p	350mVp-p	
	VOLTAGE ADJ. RANGE	By built-in potentiometer, SVR		
		24~28.8V	48~57.6V	
	VOLTAGE TOLERANCE Note.3	±1.0%	±1.0%	
	LINE REGULATION	±0.5%	±0.5%	
	LOAD REGULATION	±0.5%	±0.5%	
SETUP, RISE TIME Note.4	1800ms, 60ms/230VAC 1800ms, 60ms/115VAC at full load			
HOLD UP TIME (Typ.) Note.4	16ms/230VAC at 75% load	10ms/230VAC at full load ; 16ms/115VAC at 75% load	10ms/115VAC at full load	
INPUT	VOLTAGE RANGE Note.4	90 ~ 264VAC	250 ~ 370VDC	
	FREQUENCY RANGE	47 ~ 63Hz		
	POWER FACTOR (Typ.) Note.4	PF≥0.95/230VAC	PF≥0.99/115VAC at full load	
	EFFICIENCY (Typ.)	95%	96%	
	AC CURRENT (Typ.)	11A/115VAC	8A/230VAC	
	INRUSH CURRENT (Typ.)	Cold start 30A/115VAC	60A/230VAC	
LEAKAGE CURRENT	<0.75mA / 240VAC			
PROTECTION	OVERLOAD	105~125% rated current Protection type : Constant current limiting, shut down O/P voltage after 5 sec. After O/P voltage falls, re-power on to recover		
	SHORT CIRCUIT	Constant current limiting, unit will shutdown after 5 sec, re-power on to recover.		
	OVER VOLTAGE	30 ~ 35V	60 ~ 67V	
		Protection type : Shut down O/P voltage, re-power on to recover		
OVER TEMPERATURE	Protection type : Shut down O/P voltage, recovers automatically after temperature goes down			
FUNCTION	OUTPUT VOLTAGE PROGRAMMABLE(PV) Note.5	Adjustment of output voltage is allowable to 50 ~ 120% of nominal output voltage Please refer to the Function Manual.		
	OUTPUT CURRENT PROGRAMMABLE(PC) Note.5	Adjustment of constant current level is allowable to 20 ~ 100% of rated current. Please refer to the Function Manual.		
	REMOTE ON/OFF CONTROL	Power ON : Short circuit Power OFF : Open circuit		
	AUXILIARY POWER	12V @ 0.4A tolerance ±10%, ripple=150mVp-p		
	DC-OK SIGNAL	The TTL signal out, PSU turn on = 4.4 ~ 5.5V ; PSU turn off = -0.5 ~ 0.5V. Please refer to the Function Manual.		
ENVIRONMENT	WORKING TEMP.	-30 ~ +70°C (Refer to "Derating Curve")		
	WORKING HUMIDITY	20 ~ 90% RH non-condensing		
	STORAGE TEMP., HUMIDITY	-40 ~ +85°C, 10 ~ 95% RH non-condensing		
	TEMP. COEFFICIENT	±0.03%/°C (0 ~ 50°C)		
	VIBRATION	10 ~ 500Hz, 5G 10min./1cycle, 60min. each along X, Y, Z axes		
SAFETY & EMC (Note.7)	SAFETY STANDARDS	UL62368-1, DEKRA BS EN/EN62368-1, EAC TP TC 004 approved		
	WITHSTAND VOLTAGE	I/P-O/P:3.75KVAC I/P-FG:2KVAC O/P-FG:1.25KVAC		
	ISOLATION RESISTANCE	I/P-O/P, I/P-FG, O/P-FG:100M Ohms/500VDC/25°C / 70%RH		
	EMC EMISSION	Parameter	Standard	Test Level / Note
Conducted		BS EN/EN55032 (CISPR32)	Class B	
Radiated		BS EN/EN55032 (CISPR32)	Class A	
Harmonic Current		BS EN/EN61000-3-2	Class A	
Voltage Flicker		BS EN/EN61000-3-3	-----	
BS EN/EN55035, BS EN/EN61000-6-2				
Parameter		Standard	Test Level / Note	
ESD		BS EN/EN61000-4-2	Level 3, 8KV air ; Level 2, 4KV contact	
Radiated		BS EN/EN61000-4-3	Level 3	
EFT / Burst		BS EN/EN61000-4-4	Level 3	
Surge	BS EN/EN61000-6-2	2KV/Line-Line 4KV/Line-Earth		
Conducted	BS EN/EN61000-4-6	Level 3		
Magnetic Field	BS EN/EN61000-4-8	Level 4		
Voltage Dips and Interruptions	BS EN/EN61000-4-11	>95% dip 0.5 periods, 30% dip 25 periods, >95% interruptions 250 periods		
OTHERS	MTBF	535.4K hrs min. Telcordia SR-332 (Bellcore) ; 56.7K hrs min. MIL-HDBK-217F (25°C)		
	DIMENSION	290*140*41mm (L*W*H)		
	PACKING	2.51kg ; 6pcs/15.15kg/0.86CUFT		
NOTE	<ol style="list-style-type: none"> All parameters NOT specially mentioned are measured at 230VAC input, rated load and 25°C of ambient temperature. Ripple & noise are measured at 20MHz of bandwidth by using a 12" twisted pair-wire terminated with a 0.1uf & 47uf parallel capacitor. Tolerance :includes set up tolerance, line regulation and load regulation. Derating may be needed under low input voltages. Please check the derating curve and Static characteristics for more details. PV/PC functions when users do not use SVR. Output will shut down after O/P voltage is below < 80% of Vset for 5 sec, re-power on to recover. The power supply is considered a component which will be installed into a final equipment. All the EMC tests are been executed by mounting the unit on a 720mm*360mm metal plate with 1mm of thickness. The final equipment must be re-confirmed that it still meets EMC directives. For guidance on how to perform these EMC tests, please refer to "EMI testing of component power supplies." (as available on https://www.meanwell.com/Upload/PDF/EMI_statement_en.pdf) The ambient temperature derating of 3.5°C/1000m with fanless models and of 5°C/1000m with fan models for operating altitude higher than 2000m(6500ft). <p>※ Product Liability Disclaimer : For detailed information, please refer to https://www.meanwell.com/serviceDisclaimer.aspx</p>			

BLOCK DIAGRAM

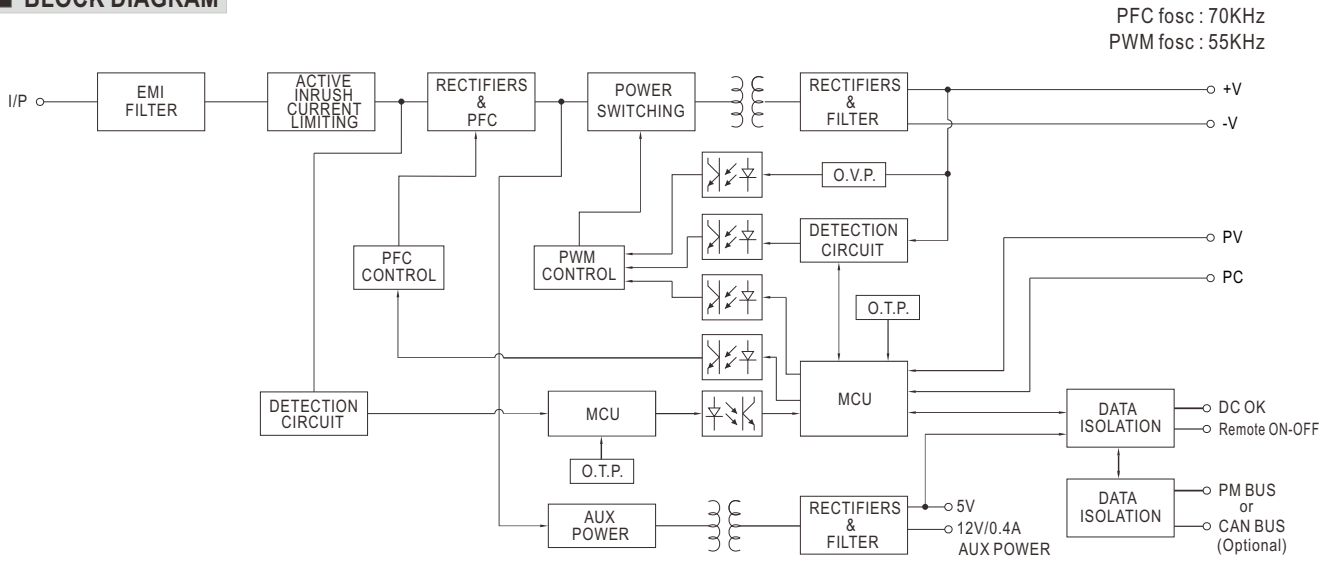

STATIC CHARACTERISTIC

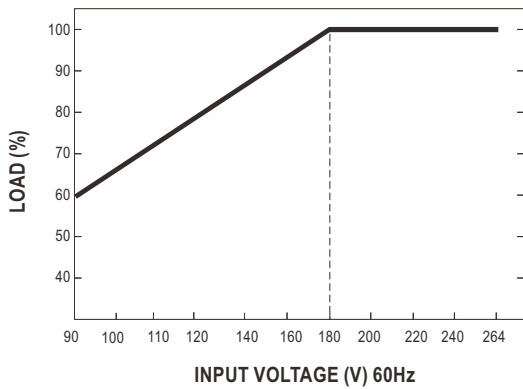

EFFICIENCY VS LOAD (48V MODEL)

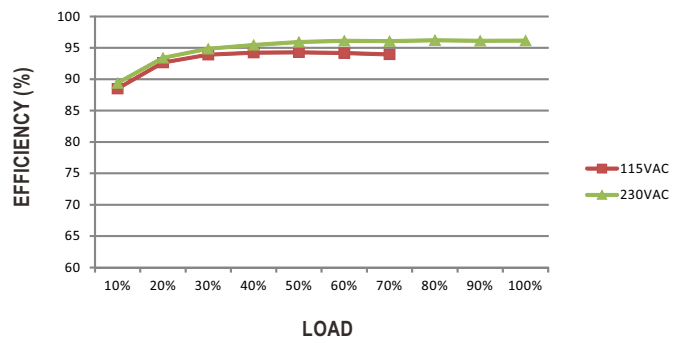

DERATING CURVE

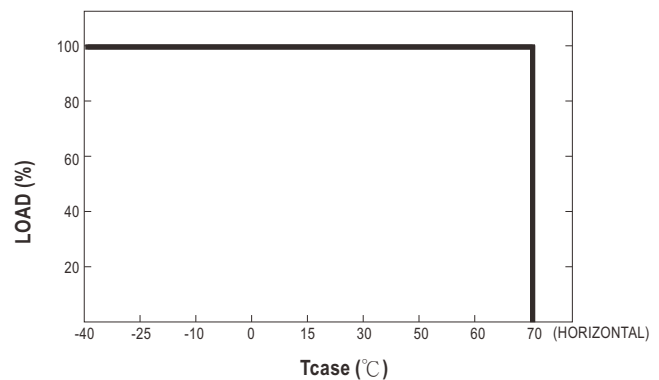
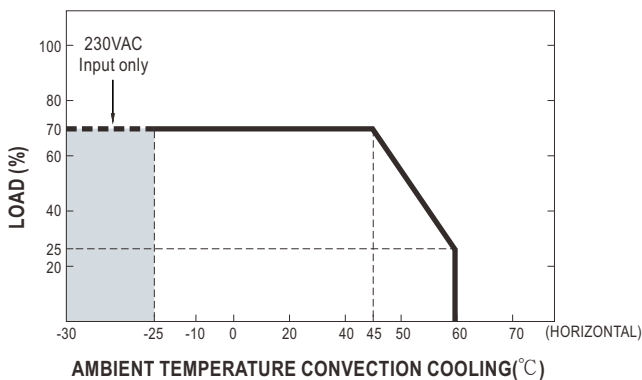
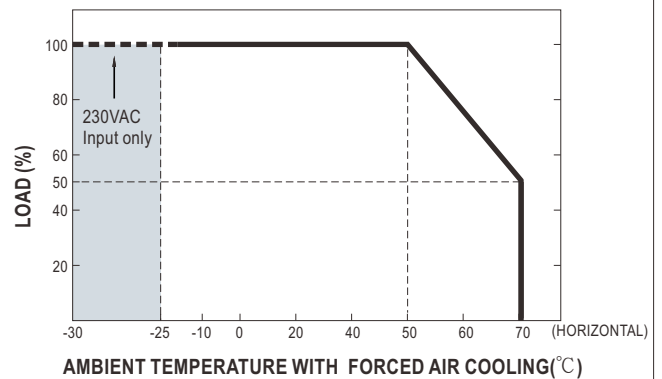
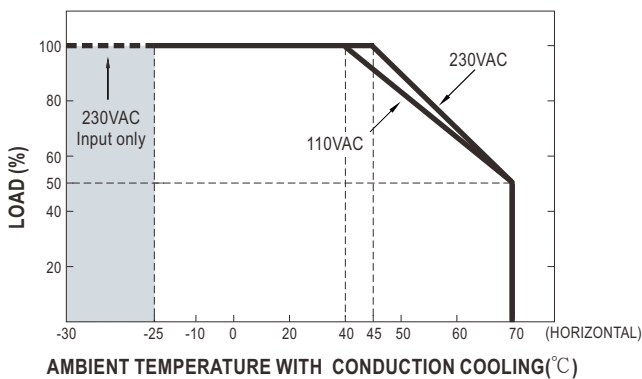

FUNCTION MANUAL

1. Output Voltage Programming (or, PV / remote voltage programming / remote adjust / margin programming / dynamic voltage trim)

※ In addition to the adjustment via the built-in potentiometer, the output voltage can be trimmed by applying EXTERNAL VOLTAGE.

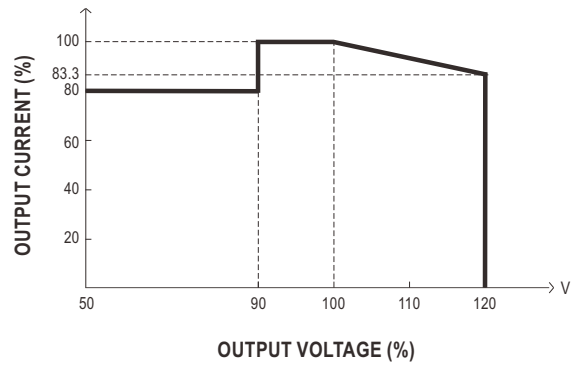
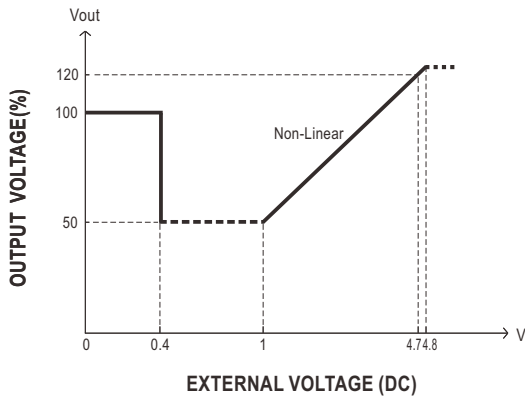
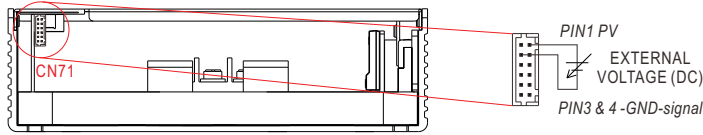

© The rated current should change with the Output Voltage Programming accordingly.

2. Constant Current Programming (or, PC / remote current programming / dynamic current trim)

※ The output current can be trimmed to 20~100% of the rated current by applying EXTERNAL VOLTAGE.

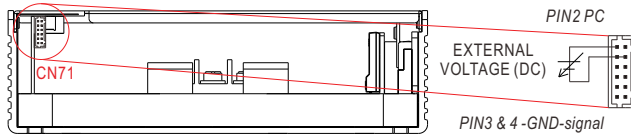

© Output will shut down after O/P voltage is below < 80% of Vset for 5 sec, re-power on to recover.

※ Covered by over temperature protection, auto de-rating function works under operation either in PC mode or under control by communication protocol.

T₁(Typ.): Maximum ambient temperature of full load.

T₂(Typ.): T₁+5°C.

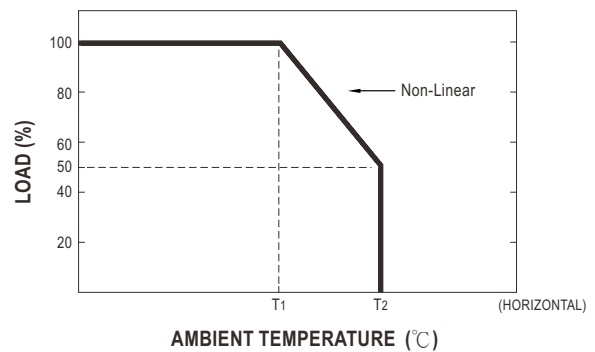
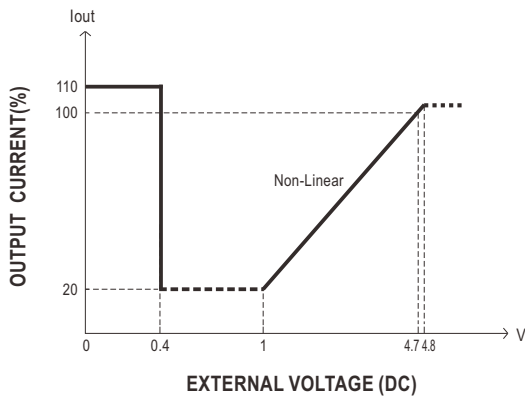

3. Remote ON-OFF Control

The power supply can be turned ON/OFF individually or along with other units in parallel by using the "Remote ON-OFF" function.

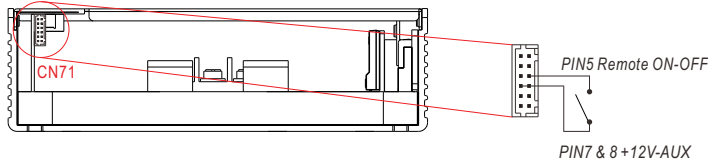

Remote ON-OFF	Power Supply Status
Short circuit	ON
Open circuit	OFF

4. DC-OK Signal

DC-OK signal is a TTL level signal. The maximum sink current is 10mA and the maximum external voltage is 5.6V.

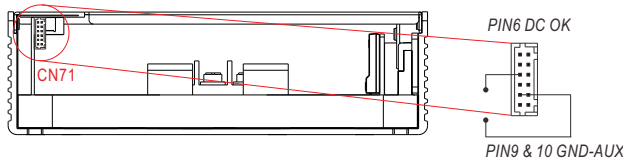

DC-OK signal	Power Supply Status
"High" >4.4~5.5V	ON
"Low" <-0.5~0.5V	OFF

5. PMBus Communication Interface

UHP-1500 supports PMBus Rev. 1.1 with maximum 100KHz bus speed, allowing information reading, status monitoring, output trimming, etc. For details, please refer to the Function Manual.

UHP-1500 Series

1500W Conduction Cooling with PFC Switching Supply



MECHANICAL SPECIFICATION

(Unit: mm, tolerance $\pm 0.5\text{mm}$)

Case No.277A

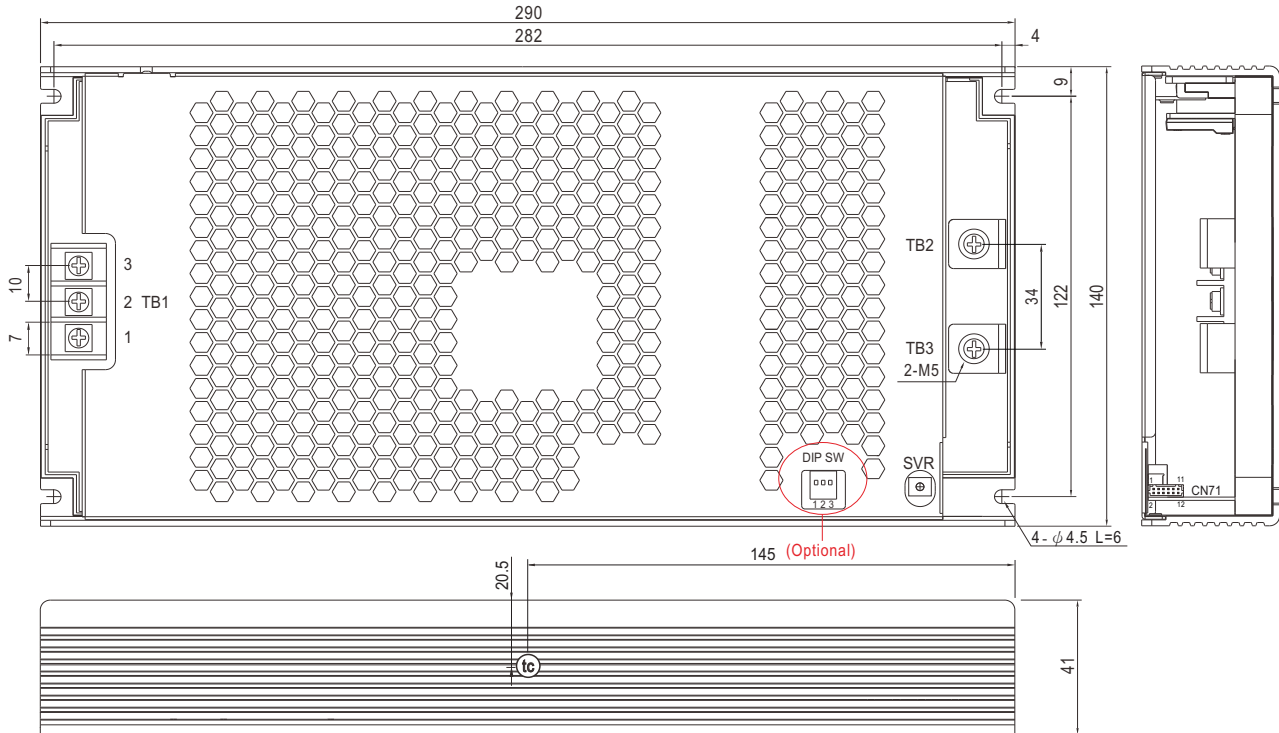

• (tc) : Max. Case Temperature

AC Input Terminal(TB1) Pin NO. Assignment

Pin No.	Assignment	Terminal	Max mounting torque
1	AC/L	DECA T25	18Kgf-cm
2	AC/N		
3	⊥		

DC Output Terminal(TB2, TB3) Pin NO. Assignment

Pin No.	Assignment	Terminal	Max mounting torque
TB2	+V	(MW)	8Kgf-cm
TB3	-V	HS455A	

※DIP SW:

Pin No.	Function	Description
1	A0	PMBus / CANBus interface address switch.
2	A1	
3	A2	

※Control Pin No. Assignment(CN71) : HRS DF11-12DP-2DS or equivalent



Mating Housing	HRS DF11-12DS or equivalent
Terminal	HRS DF11-12SC or equivalent

Pin No.	Function	Description
1	PV	Connection for output voltage programming.(Note 1)
2	PC	Connection for constant current level programming.(Note.1)
3,4	GND (Signal)	Negative output voltage signal.
5	Remote ON-OFF	The unit can turn the output ON/OFF by dry contact between Remote ON/OFF and 12-AUX.(Note.2) Short (10.8 ~ 13.2V) : Power ON ; Open(0 ~ 0.5V) : Power OFF ; The maximum input voltage is 13.2V
6	DC-OK	Low (-0.5 ~ 0.5V) : When the $V_{out} \leq 80\% \pm 6\%$. High (4.4 ~ 5.5V) : When $V_{out} \geq 80\% \pm 6\%$. The maximum sourcing current is 10mA and only for output.(Note.2)
7,8	+12V-AUX	Auxiliary voltage output, 10.6~13.2V, referenced to GND-AUX (pin9 & 10). The maximum load current is 0.4A. This output is not controlled by "Remote ON-OFF".
9,10	GND-AUX	Auxiliary voltage output GND. The signal return is isolated from the output terminals (+V & -V).
11	SDA	For PMBus model: Serial Data used in the PMBus interface. (Note.2)
	CANH	For CANBus model: Data line used in CANBus interface. (Note.2)
12	SCL	For PMBus model: Serial Clock used in the PMBus interface. (Note.2)
	CANL	For CANBus model: Data line used in CANBus interface. (Note.2)

Note1: Non-isolated signal, referenced to [GND(signal)].

Note2: Isolated signal, referenced to GND-AUX.

UHP-1500 Series

1500W Conduction Cooling with PFC Switching Supply



Operate with additional aluminum plate

In order to meet the "Derating Curve" and the "Static Characteristics", UHP-1500 series must be installed onto an aluminum plate (or the cabinet of the same size) on the bottom. The size of the suggested aluminum plate is shown as below. And for optimizing thermal performance, the aluminum plate must have an even and smooth surface (or coated with thermal grease), and UHP-1500 series must be firmly mounted at the center of the aluminum plate.

